

# SATURN 1800



Ring shaped suspended direct or direct/indirect luminaire. Top quality SMD LED modules with colour consistency MacAdams  $\leq 3$ , extensive portfolio of lumen ranges, CCTs and spectra. Variety of drivers: standard EVG on/off, DALI and wireless controlled as MasterConnect or Casambi on request. Built-in or remote, wireless occupancy & daylight sensor available to allow significant energy savings and wireless connectivity. Mounting on any type of ceiling. Body is made of rolled aluminium profile. Standard colour RAL 9003S, any other colour from basic RAL range available at no extra cost. Variety of diffusers, lumen outputs and drivers allows to use this luminaire in different types of lighting projects.

Luminous flux & Luminaire Power tolerance up to 10%. System power consumption depends on components used. Luminous efficacy depends on type of LED's, electronics, optics and diffuser. The most up to date technical parameters can be found on our website and in database of LDT files.

Lighting direction:



PDF datasheet:



# SATURN 1800

<b>Mounting:</b>	Suspended
<b>Body material:</b>	Aluminium profile
<b>Colour:</b>	Standard white RAL 9003S, other RAL colours on request
<b>Lumen output:</b>	Standard up to 20.000 lm, any other on request
<b>LED module:</b>	Signify (Philips), Tridonic or equivalent SMD LED module
<b>Colour temperature:</b>	3000/4000K/2700-6500K TW, other on request
<b>Colour Rendering:</b>	CRI>80 in standard, other on request
<b>Driver:</b>	EVG on-off/DALI/TW DT8/MC ( MasterConnect )/Casambi, other on request
<b>Wireless control:</b>	Philips MasterConnect / Casambi, other on request
<b>Daylight/Occupancy sensor:</b>	Built-in XC sensor or wireless MCS sensor
<b>Emergency unit:</b>	On request
<b>Operating temperature range:</b>	0°C ... +35°C
<b>IP Class:</b>	IP20 in standard
<b>Power:</b>	220-240V 50/60Hz
<b>Lighting direction:</b>	Direct, direct/indirect lighting
<b>Light distribution:</b>	Symmetric
<b>Diffuser:</b>	OP white acrylic, MP19H microprismatic UGR<19
<b>Beam angle:</b>	All types available in our LDT file database
<b>Warranty:</b>	5 Years standard warranty

**SATURN 1800 PND DN** suspended, light down

**SATURN 1800 PND UP\_DN** suspended, light up & down



Energy saving MasterConnect wireless lighting control system with daylight and movement detection technology on request.



Zigbee



Bluetooth

All current index numbers, lumen outputs, power consumption and many other technical information are available in our 2024 pricelist. Details on wireless lighting control systems on page number 896.



XC daylight&occ sensor



OP opal diffuser

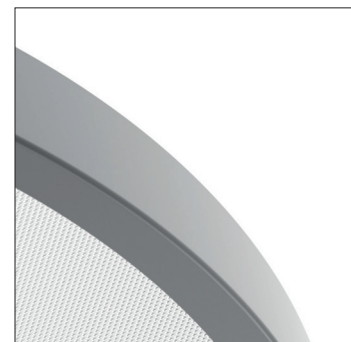

MP19H microprismatic diffuser



MCS wireless daylight&occ sensor



XCS wireless switch

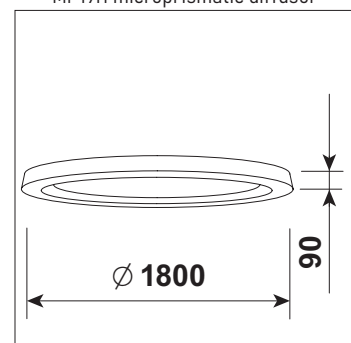

Basic dimensions